

SAA Fixed Wing Power - Gold Schedule - Flight Components

KEY: - Start Point: ● End Point: → Centre Line: ↑ Upright:  Inverted:  Topside:  Underside:  Wind Direction: 

1. Take Off and Procedure Turn, Reverse Cuban Eight, ½ Cuban Eight

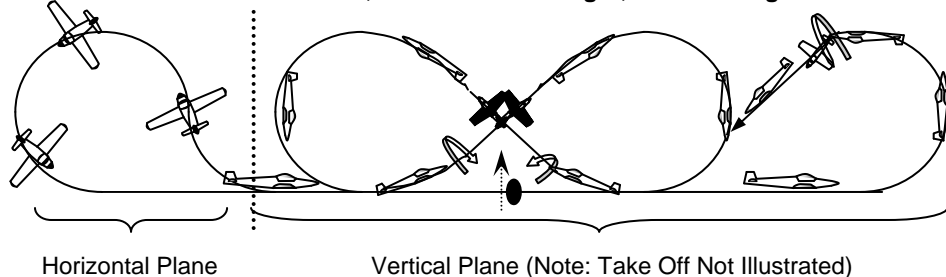

2. Two Consecutive Loops, Stall turn with Half Roll in Up & Down Legs

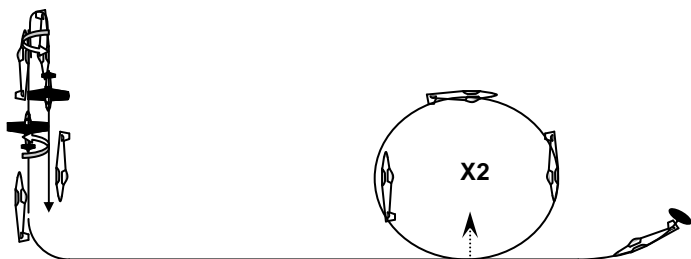

3. Three Consecutive Rolls (Centre aligned with Pilot), Vertical Reversal with Half Roll in Up-line

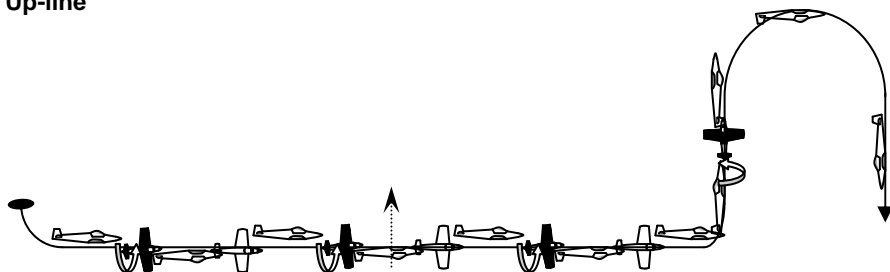

4. Four Point Roll, ½ Reversal Cuban 8 (2 points of a 4 Point Roll in Up-line)

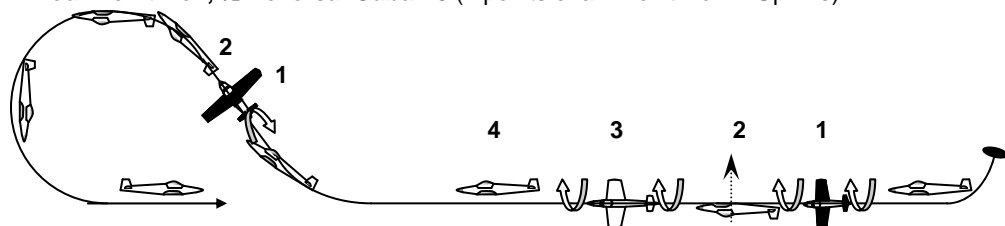

5. Two Consecutive Rolls (Opposite Direction), Immelman Turn, Two Outside Loops (NOTE: bottom of O.Is. not shown), ½ Outside Loop

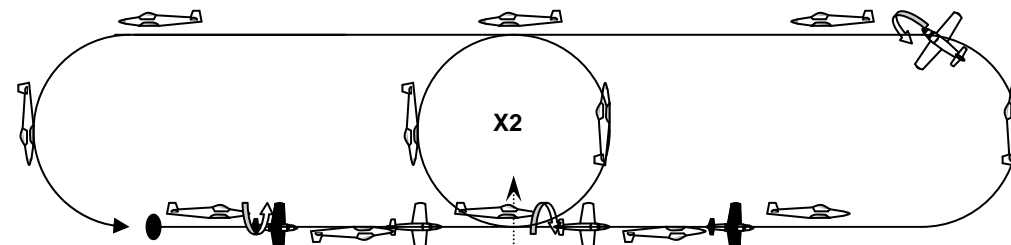

6. Inverted Pass, Vertical Pull Through, Vertical 8, Split S

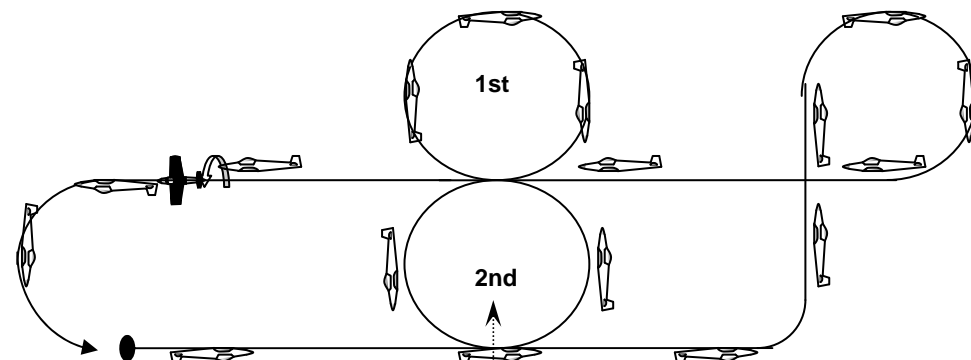

7. Slow Roll, ½ Square loop, ½ Roll, Minimum Speed Pass, One Turn Spin

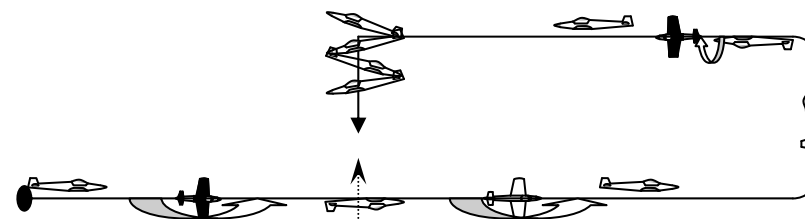

8. Rectangular Circuit and Landing (Horizontal Plane)

